

**VACUUM FLUORESCENT DISPLAY
MODULE
SPECIFICATION**

MODEL : CU16025-TW200A

SPECIFICATION NO. : DS-1240-0000-01

DATE OF ISSUE : May 23, 2005(00)

REVISION : July 26, 2005(01)

PUBLISHED BY
NORITAKE ITRON CORP. / JAPAN

This specification is subject to change without prior notice.

Index

1. General Description	3
1.1 Application	3
1.2 Construction.....	3
1.3 Drawing.....	3
2. Absolute Maximum Ratings.....	3
3. Electrical Ratings.....	3
4. Electrical Characteristics	3
5. Optical Specifications	4
6. Environmental Specifications	4
7. Functional Descriptions.....	4
7.1 Character data write	4
7.2 Control data write.....	4
7.2.1 BS : Back Space (08 Hex).....	4
7.2.2 HT : Horizontal Tab (09 Hex)	5
7.2.3 LF : Line Feed (0A Hex).....	5
7.2.4 FF : Form Feed (0C Hex)	5
7.2.5 CR : Carriage Return (0D Hex)	5
7.2.6 CLR: Clear (0E Hex)	5
7.2.7 CAN: Cancel (0F Hex).....	5
7.2.8 DC1 : Device Control 1 (11 Hex) ... Character over write mode	5
DC2 : Device Control 2 (12 Hex) ... Scroll up mode	5
DC3 : Device Control 3 (13 Hex) ... Horizontal Scroll mode	5
7.2.9 DC4 : Device Control 4 (14 Hex) ... Cursor is turned to invisible. (Default).....	6
DC5 : Device Control 5 (15 Hex) ... Cursor is displayed as a blinking all dot character	6
DC6 : Device Control 6 (16 Hex) ... Cursor is turned to invisible.....	6
DC7 : Device Control 7 (17 Hex) ... Cursor is turned to invisible.....	6
7.2.10 CT0 : Character Table 0 (18 Hex) ... International character font.....	6
CT1 : Character Table 1 (19 Hex) ... KATAKANA character font.....	6
EUR: Euro Currency mark (1AH) ... Euro Currency mark	6
7.2.11 ESC : Escape (1B Hex)	6
7.3 Test Mode	9
7.4 Character and control code table	10
7.4.1 International character font	10
7.4.2 KATAKANA character font	11
8. Timing.....	12
8.1 Parallel interface Timing	12
8.2 Serial Interface Timing	12
8.3 Reset Timing	13
9. BUSY Time	13
10. Jumper wires.....	14
11. Connector Pin assignment.....	15
11.1 22pin Connector.....	15
11.2 3pin Connector	15
12. Outline dimension.....	16
Notice for the Cautious Handling VFD Modules	17

1. General Description

1.1 Application

Readout of computer, micro-computer, communication terminal and automatic instruments.

1.2 Construction

Single board display module consists of 32 character(2 x 16) VFD, refresh memory, character generator, control circuit, DC/DC converter and all necessary control logics. Interface level is TTL compatible and the module can be connected to the CPU bus of host directly.

1.3 Drawing

See attached drawings.

2. Absolute Maximum Ratings

Parameter	Symbol	Min.	Typ.	Max.	Unit	Condition
Logic Input Voltage	VI	0	-	5.5	VDC	-
Power Supply Voltage	Vcc	0	-	6.5	VDC	-

3. Electrical Ratings

Parameter	Symbol	Min.	Typ.	Max.	Unit	Condition
Logic Input Voltage D7-D0, *WR,*CS	"H"	VIH	2.0	-	VCC	Vcc=5.0V TA=25degrees
	"L"	VIL	0	-	0.8	
Logic Input Voltage *RESET	"H"	VIH	3.5	-	-	
	"L"	VIL	-	-	1.5	
Power Supply Voltage	Vcc	4.75	5.0	5.25	VDC	-

4. Electrical Characteristics

Measuring Conditions : TA (Ambient temperature)=25degrees, Vcc=5.0V

Parameter	Symbol	Min.	Typ.	Max.	Unit	Condition
Logic Output Voltage	"H"	VOH	2.4	-	-	VDC IOH=-8mA
	"L"	VOL	-	-	0.5	VDC IOL=8mA
Power Supply Current	Icc	-	130	170	mADC	-

Note :Icc shows the current at all dots in the screen are lighted.

Slow start power supply may cause erroneous operation. The rise time of Vcc should not exceed 100 ms.

Icc might be anticipated twice as usual at power on rush.

5. Optical Specifications

- Number of characters : 32(2 lines x 16 chars)
- Matrix format : 5 x 7 dot
- Display area : 61.8 x 13.4mm (X x Y)
- Character size : 2.55 x 4.7 mm (X x Y)
- Character pitch : 3.95 x 8.7 mm (X x Y)
- Dot size : 0.35 x 0.5 mm (X x Y)
- Dot pitch : 0.55 x 0.7 mm (X x Y)
- Luminance : 350 cd/m2 (102fL) Min.
- Color of illumination : Green(Blue-green)

6. Environmental Specifications

- Operating temperature : -40 to +85 degrees
- Storage temperature : -40 to +85 degrees
- Operating humidity : 20 to 80 % RH (No Condensation)
- Vibration(No operating) : 10 to 55 Hz, all amplitude 1mm, X,Y,Z 3direction
30 minutes
- Shock(No operating) : 100G, 9ms, X Y Z 3direction

7. Functional Descriptions

This module provides the functions of 8 bit parallel and serial data write.

Each control data and character fonts are shown in Character Table 0 and Character Table 1.

All data write should be done during BUSY line is low.

CS	\overline{WR}	Function	Bus direction
0	↑	Data write	Module ← Host
1	X	No operation	Module X Host

↑:Rising edge of pulse X: Do not care

7.1 Character data write

Character font is displayed on the screen, and HT is executed. (see para. 7.2.2 HT)

7.2 Control data write

Detail of control data are shown in this clause . The term "Cursor" is the same meaning of "Writing Position".

7.2.1 BS : Back Space (08 Hex)

The cursor moves one character to the left.

At the left end, it moves to the upper right end.

At the top left end, the cursor doesn't move.

7.2.2 HT : Horizontal Tab (09 Hex)

The cursor moves one character to the right.

At the right end, the cursor motion depends upon DC1, DC2 and DC3 mode.

DC1 : The cursor moves to the lower left end.

DC2 : The cursor moves to the lower left end.

DC3 : The cursor overflow. Furthermore, if HT is inputted continuously, all displayed characters on the cursor line are scrolled to the left one character, and the blank is appeared at the right end of cursor line.

The other displayed characters on the other line are not changed.

At the bottom right end, the cursor motion depends upon DC1, DC2 and DC3 mode.

DC1 : The cursor moves to the top left end.

DC2 : All displayed characters are scrolled up one line.

The cursor moves to the bottom left end and all written characters in the top line is disappeared. The bottom line is cleared.

DC3 : The cursor overflow. Furthermore, if HT is inputted continuously, all displayed characters on the cursor line are scrolled to the left one character, and the blank is appeared at the right end of cursor line.

The other displayed characters on the other line are not changed.

7.2.3 LF : Line Feed (0A Hex)

The cursor moves to the same column on the lower line except DC3 mode.

At the DC3 mode, All displayed characters and cursor position are not changed in any line.

At the bottom line, it is depends upon DC1 or DC2 mode.

DC1 : The cursor moves to the same column on the top line.

DC2 : All displayed characters are scrolled up one line.

The cursor keeps the same column on the bottom line, and the bottom line is cleared.

7.2.4 FF : Form Feed (0C Hex)

The cursor moves to the top left end.

7.2.5 CR : Carriage Return (0D Hex)

The cursor moves to the left end on the same line.

7.2.6 CLR: Clear (0E Hex)

All displayed characters are cleared. The cursor doesn't move.

7.2.7 CAN: Cancel (0F Hex)

All displayed characters on the cursor line are cleared. The other displayed characters on the other line are not changed. The cursor doesn't move.

7.2.8 DC1 : Device Control 1 (11 Hex) ... Character over write mode

DC2 : Device Control 2 (12 Hex) ... Scroll up mode

DC3 : Device Control 3 (13 Hex) ... Horizontal Scroll mode

Alternative LINE ENDING MODE is specified by DC1, DC2 and DC3 when character data or HT or LF is written. Just after power on or initialize, DC1 is selected (Default Mode).

7.2.9 DC4 : Device Control 4 (14 Hex) ... Cursor is turned to invisible. (Default)**DC5 : Device Control 5 (15 Hex) ... Cursor is displayed as a blinking all dot character.****DC6 : Device Control 6 (16 Hex) ... Cursor is turned to invisible.****DC7 : Device Control 7 (17 Hex) ... Cursor is turned to invisible.**

Above four codes control the cursor rendition. DC4 is default mode. The mode is maintained until other mode is selected. The blinking speed can be varied by ESC sequence. (see para. 7.2.11 ESC)

7.2.10 CT0 : Character Table 0 (18 Hex) ... International character font**CT1 : Character Table 1 (19 Hex) ... KATAKANA character font**

Above two codes select Character Table. Just after power on, CT0 is selected(Default Mode). Any characters from those 2 tables can be displayed on the screen by the bank selection.

EUR: Euro Currency mark (1AH) ... Euro Currency mark

Euro Currency mark is stored instead of Blank in character code location AD Hex of CT0.

This is replaced to Blank if CT0 is selected again, and it affects displayed character of AD Hex.

7.2.11 ESC : Escape (1B Hex)

The character or data strings succeeding of ESC code control the various functions such as user definable font, cursor addressing, screen luminance control, selection of data writing mode, blink speed control and initialize.

(1) User Definable Font (UDF)

Users desired fonts can be defined by software. The fonts will be memorized in RAM of the CPU.

Syntax : ESC (1B Hex) + "C" (43 Hex) + CHR + PT1 + PT2 + PT3 + PT4 + PT5

Any 5x7 dot patterns consisted of data from PT1 thru PT5 can be stored in character code location specified by CHR.

Maximum number of UDF are 16 characters at once. Storing more than 16 will kill the oldest font. However, within the 16 character codes where already defined by UDF, the over-write-latest font replaces the former font.

1st byte : ESC(1B Hex)

2nd byte : "C"(43 Hex)

3rd byte : CHR(00 Hex to FF Hex)

Specify the character code location from 00 Hex to FF Hex by CHR.

If CHR overlaps the control codes such as BS, HT, etc. , the control function will be lost. And therefore, the overlap to the ESC code may not avail further UDF.

4th to 8th byte : PT 1 through PT5

Specify ON or OFF of 35 dot position (5x7 dot)

Following table shows the relation of dot position and the data formation ("1" = dot turn on, "0" = dot turn off)

	7(MSB)	6	5	4	3	2	1	0(LSB)
4th byte	P8	P7	P6	P5	P4	P3	P2	P1
5th byte	P16	P15	P14	P13	P12	P11	P10	P9
6th byte	P24	P23	P22	P21	P20	P19	P18	P17
7th byte	P32	P31	P30	P29	P28	P27	P26	P25
8th byte	*	*	*	*	*	P35	P34	P33

* : don't care

Following is the dot assignment.

P1	P2	P3	P4	P5
P6	P7	P8	P9	P10
P11	P12	P13	P14	P15
P16	P17	P18	P19	P20
P21	P22	P23	P24	P25
P26	P27	P28	P29	P30
P31	P32	P33	P34	P35

After execution of above sequence, a defined font will be stored in the character code location "CHR" (Hex)

Following is an example of UDF sequence.

Example : "!" dot pattern should be stored in character code location A0 Hex.

		●			P3
		●			P8
		●			P13
		●			P18
		●			P33

Assign turn on dot number to the bit table as follows.

	b7	b6	b5	b4	b3	b2	b1	b0	Data (Hex)
4th byte	1	0	0	0	0	1	0	0	84
5th byte	0	0	0	1	0	0	0	0	10
6th byte	0	0	0	0	0	0	1	0	02
7th byte	0	0	0	0	0	0	0	0	00
8th byte	0	0	0	0	0	0	0	1	01

Then Syntax should be written : 1B + 43 + A0 + 84 + 10 + 02 + 00 + 01 (Hex)

(2) Cursor Moving

The cursor can be moved to any position of the screen by following ESC sequence.

Syntax : ESC (1B Hex) + "H" (48 Hex) + 1 Byte data

Column \ Line	Left end	2nd	3rd	-----	Right end
Top	00	01	02	-----	0F
2nd	10	11	12	-----	1F

Data = 20 Hex to FF Hex : The cursor doesn't move.

(3) Luminance Control

The screen luminance can be varied by following ESC sequence.
Just after power on, the screen luminance is set to 100%.

Syntax : ESC (1B Hex) + " L " (4C Hex) + 1 Byte data

Data = 00 Hex to 3F Hex : approx. 30%
 40 Hex to 7F Hex : approx. 50%
 80 Hex to BF Hex : approx. 75%
 C0 Hex to FF Hex : 100%

(4) Selection of Writing Mode

Flicker less Mode can be selected by following ESC sequence.

Syntax : ESC (1B Hex) + "S" (53 Hex) ... Flicker less Mode

Within Flicker less Mode, although BUSY might become longer, flicker less-high speed-continuous-data write can be achieved since refreshing of the screen has priority over the data acceptance.

Quick data write with minimum BUSY time will be given by Quick Write Mode since the data acceptance has the priority over the refreshing of the screen.

Within this mode, continuous high speed data write may cause flicker display.

Note :

When serial data write with high speed baud rate at Flicker less Mode, it may have the read error of the data. Busy check within Flicker less Mode or setting to the Quick Write Mode is recommended for serial data write.

Just after power on or initialize, Quick Write Mode is selected until other mode is set. After selected Flicker less Mode, Quick Write Mode can't be selected unless otherwise initialize.

(5) Blink Speed Control

Blinking speed of cursor can be varied by following ESC sequence.

Syntax : ESC (1B Hex) + "T" (54 Hex) + 1 Byte Data

Data = 00	Hex ...	256
FF	Hex ...	255
FE	Hex ...	254
:		
01	Hex ...	1

Period of Blinking = Data Value x Approx.28 mS

At power on default, 20 (14 Hex) is set to data.

(6) Initialize

All displayed characters and all setting factors are cleared by following ESC sequence.

Syntax : ESC (1B Hex) + "I" (49 Hex)

Execution of above sequence, module is reset as just after power on.

7.3 Test Mode

Test Mode is set by keeping SIN (T0) is low for more than 100mS at power on or initialize. During Test Mode, all character fonts are displayed automatically, and no any data are acceptable.

7.4 Character and control code table

Following 2 character tables can be selected. (see para. 7.2.9)

7.4.1 International character font

D7	0	0	0	0	0	0	0	0	1	1	1	1	1	1	1	1
D6	0	0	0	0	1	1	1	1	0	0	0	1	1	1	1	1
D5	0	0	1	1	0	0	1	1	0	0	1	1	0	0	1	1
D4	0	1	0	1	0	1	0	1	0	1	0	1	0	1	0	1
D D D D 3 2 1 0	0	1	2	3	4	5	6	7	8	9	A	B	C	D	E	F
0 0 0 0 0			SP	ø	ä	å	´	æ	ë							
0 0 0 1 1	DC1	!														
0 0 1 0 2	DC2	"														
0 0 1 1 3	DC3	#														
0 1 0 0 4	DC4	\$														
0 1 0 1 5	DC5	%														
0 1 1 0 6	DC6	&														
0 1 1 1 7	DC7	'														
1 0 0 0 8	BS CT0	<														
1 0 0 1 9	HT CT1)														
1 0 1 0 A	LF EUR	* #														
1 0 1 1 B	ESC	+ :														
1 1 0 0 C	FF	, <														
1 1 0 1 D	CR	- =														
1 1 1 0 E	CLR	. >														
1 1 1 1 F	CAN	/ ?														

CFX101

Character Table 0

Note: When EUR(1AH) is selected, Euro Currency mark is stored instead of Blank in character code location AD Hex of CT0. This is replaced to Blank if CT0 is selected again, and it affects displayed character of AD Hex.

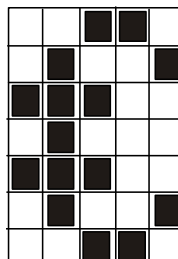

7.4.2 KATAKANA character font

	D7	0	0	0	0	0	0	0	0	1	1	1	1	1	1	1	1
	D6	0	0	0	0	1	1	1	1	0	0	0	1	1	1	1	1
	D5	0	0	1	1	0	0	1	1	0	0	1	1	0	0	1	1
	D4	0	1	0	1	0	1	0	1	0	1	0	1	0	1	0	1
D D D D		0	1	2	3	4	5	6	7	8	9	A	B	C	D	E	F
3 2 1 0																	
0 0 0 0 0				SP	0	0	P	\	f	E	N		-	タ	三	日	!
0 0 0 1 1	DC1	!	1	A	Q	a	q	r	3	。	ア	チ	△	月	■		
0 0 1 0 2	DC2	"	2	B	R	b	r	Q	W	r	イ	ツ	×	火	■		
0 0 1 1 3	DC3	#	3	C	S	c	s	*	9	」	ウ	テ	モ	*	■		
0 1 0 0 4	DC4	\$	4	D	T	d	t	3	G	\	工	ト	ナ	*	■		
0 1 0 1 5	DC5	%	5	E	U	e	u	H	0	.	オ	ナ	工	金	■		
0 1 1 0 6	DC6	&	6	F	V	f	v	4	0	7	カ	ニ	ヨ	上	■		
0 1 1 1 7	DC7	'	7	G	W	g	w	0	0	7	ナ	ナ	ラ	*	■		
1 0 0 0 8	BS CT0	<	8	H	X	h	x	7	7	イ	ク	本	リ	介	■		
1 0 0 1 9	HT CT1)	9	I	Y	i	y	9	*	o	7	ノ	も	同	7		
1 0 1 0 A	LF EUR	* :	J	Z	J	z	0	*	*	エ	コ	ン	レ	と	↓		
1 0 1 1 B	ESC	+ :	K	I	k	<	U	*	*	ウ	ヒ	ロ	ゝ	→			
1 1 0 0 C	FF	,	<	L	\	l	l	4		レ	シ	フ	フ	■	↑		
1 1 0 1 D	CR	-	=	M	I	m	>	山	山	ユ	ズ	ゝ	ン	o	←		
1 1 1 0 E	CLR	.	>	N	^	n	˘	山	7	ヨ	セ	ホ	ゝ	*	◎		
1 1 1 1 F	CAN	/	?	0	_	o	*	b	ア	ウ	リ	マ	°	◇	♪		

CFX102

Character Table 1

8. Timing

8.1 Parallel interface Timing

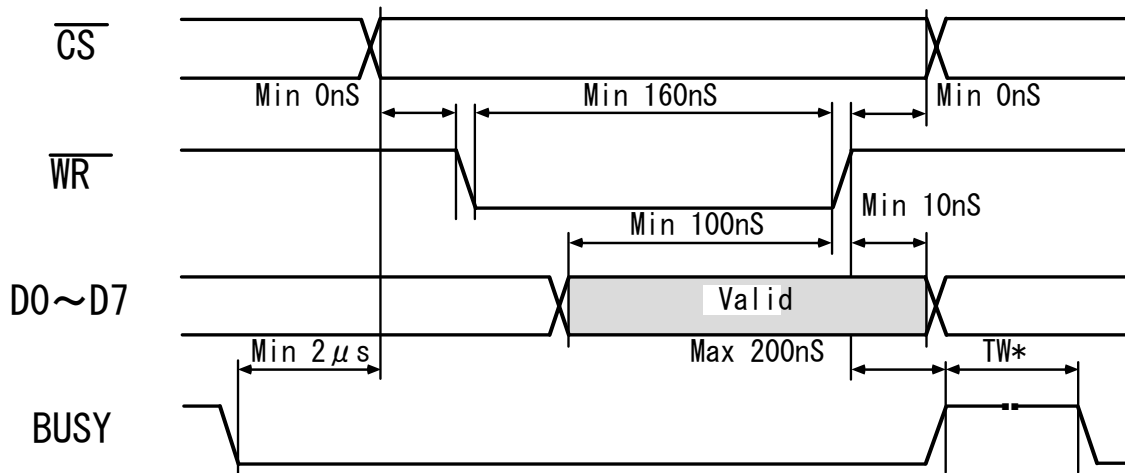

TW^* : see para 9. BUSY TIME

8.2 Serial Interface Timing

Serial data write, asynchronous-8bit TTL level is also acceptable.

Following baud rates can be selected by combination of the Jumper wires.

(see para. 10. Jumper wires)

600, 1200, 2400, 4800, 9600, 19200 BPS

Besides, parity bit-even, odd and non parity can be selected by 2 jumper wires.

(see para 10. Jumper wires)

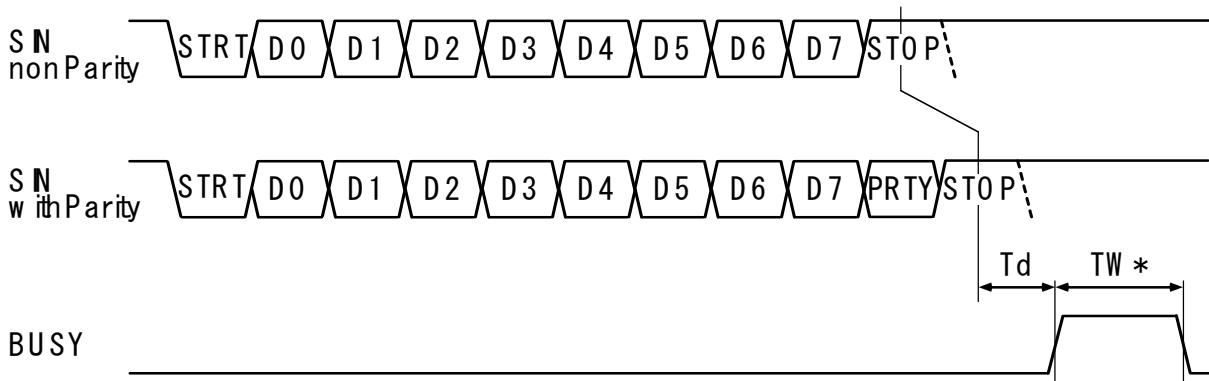

STRT : Start Bit

D0 : LSB

⋮

D7 : MSB

PRTY : Parity Bit

STOP : Stop Bit

T_d : 10µS (Typ.) at Quick Write Mode

0µS (Min.) ~ 600µS (Max.) at Flicker less Mode

TW^* : see para. 9. BUSY Time

8.3 Reset Timing

Following chart shows the reset timing.

Rest pulse (Active Low) should be longer than 1mS.

It is required at least 100mS to accept the data after reset pulse rise up

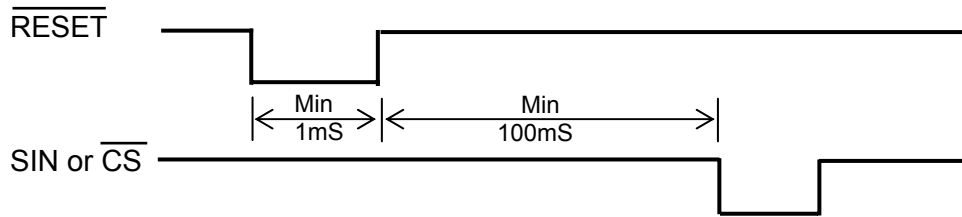

9. BUSY Time

Input data execution time (TW*) at Quick Write Mode are shown as follows.

Data		Execution time (TW)			Data Writing Mode
		DC1 Mode	DC2 Mode	DC3 Mode	
Character Data, HT, LF		180 μ S (MAX.)	350 μ S (MAX.) at scrolling	300 μ S (MAX.) at scrolling	Quick Write Mode
BS,FF,CR,CT0,CT1,EUR DC1,DC2,DC3,DC4,DC5,DC6,DC7		180 μ S (MAX.)			
CLR		500 μ S (MAX.)			
CAN		300 μ S (MAX.)			
ESC	1st byte	180 μ S (MAX.)			
	2nd byte	"C"	100 μ S (MAX.)		
		"I"	900 μ S (MAX.)		
		Expect"C", "I"	100 μ S (MAX.)		
3rd byte ~		180 μ S (MAX.)			

Above execution time are only talking about Quick Write Mode as mentioned.

Within Flicker less Mode, Approximately 2 to 15 times of above table should be considered.

Operating with Flicker less Mode, therefore, always watching of BUSY line is recommended.

10. Jumper wires

Position of jumper wire

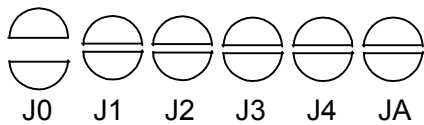
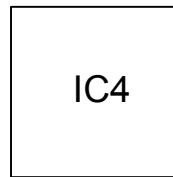

PCB Parts Side

Jumper Function Table

JA	J4	J3	J2	J1	J0	Function	
X	X	X	1	1	1	Baud rate	19200 BPS
X	X	X	1	1	0		9600 BPS
X	X	X	1	0	1		4800 BPS
X	X	X	1	0	0		2400 BPS
X	X	X	0	1	1		1200 BPS
X	X	X	0	1	0		600 BPS
X	X	X	0	0	1		600BPS
X	X	X	0	0	0		600BPS
X	1	1	X	X	X	Parity selection	Even Parity
X	1	0	X	X	X		Odd Parity
X	0	X	X	X	X		Non Parity
0	X	X	X	X	X	Character fonts selection	International Font(CT0)
1	X	X	X	X	X		Katakana Font(CT1)
0	1	1	1	1	1	Setting at Factory	

0 : short 1 : open X : Don't care

11. Connector Pin assignment

11.1 22pin Connector

No.	Terminal	No.	Terminal
1	D7	2	D6
3	D5	4	D4
5	D3	6	D2
7	D1	8	D0
9	$\overline{\text{WR}}$	10	$\overline{\text{CS}}$
11	SIN/T0	12	BUSY
13	GND	14	GND
15	VCC	16	VCC
17	VCC	18	GND
19	GND	20	GND
21	GND	22	$\overline{\text{RESET}}$

11.2 3pin Connector

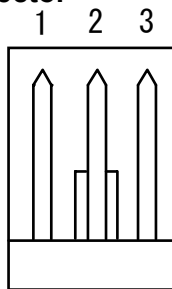

No.	Terminal
1	VCC
2	SIN/T0
3	GND

12. Outline dimension

Drawing No. DS-1240-0100-00

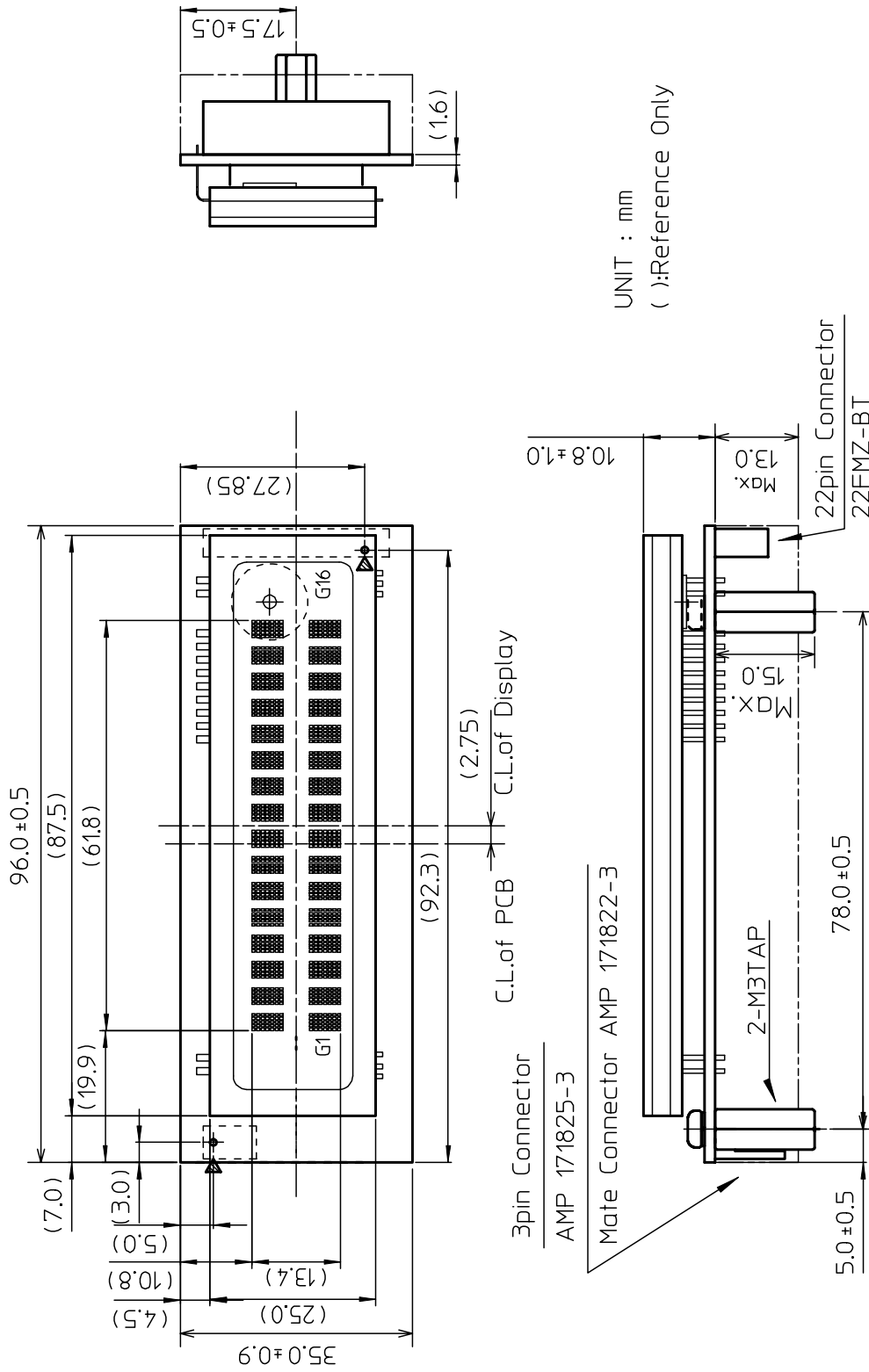

UNIT : mm
():Reference Only

Notice for the Cautious Handling VFD Modules

Handling and Usage Precautions:

Please carefully follow the appropriate product application notes for proper usage, safety handling, and operation standards for maximum performance.

[VFD tubes are made of glass]

- Because the edges of the VFD glass-envelop are not smooth, it is necessary to handle carefully to avoid injuries to your hands
- Please avoid breaking the VFD glass-envelop to prevent injury from sharp glass particles.
- The tip of the exhaust pipe is fragile so avoid shock from impact.
- It is recommended to allow sufficient open space surrounding the exhaust pipe to avoid possible damage.
- Please design the PCB for the VFD-module within 0.3 mm warping tolerance to avoid any forces that may damage the display due to PCB distortion causing a breakdown of the electrical circuit leading to VFD failure.

[High voltage]

- Avoid touching conductive electrical parts, because the VFD-module uses high voltage exceeding 30~100 volts.
- Even when electric power is turned off, it may take more than one minute for the electrical current to discharge.

[Cable connection]

- Do not unplug the power and/or data cables of VFD-modules during operating condition because unrecoverable damage may result.
- Sending input signals to the VFD-module during a power off condition sometimes causes I/O port damage.
- It is recommended to use a 30 cm or shorter signal cable to prevent functional failures.

[Electrostatic charge]

- VFD-modules need electrostatic free packaging and protection from electrostatic charges during handling and usage.

[Structure]

- During operation, VFD and VFD-modules generate heat. Please consider sufficient heat radiation dissipation using heat sink solutions.
- We prefer to use UL grade materials or components in conjunction with VFD-modules.
- Wrap and twist motion causes stress and may break VFDs & VFD modules. Please adhere to allowances within 0.3mm at the point of attachment.

[Power]

- Apply regulated power to the VFD-module within specified voltages to protect from failures.
- Because some VFD-modules may consume in rush current equal to twice the typical current at power-on timing, we recommend using a sufficient power capability and quick starting of the power regulator.
- VFD-module needs a specified voltage at the point of connection. Please use an adequate power cable to avoid a decrease in voltage. We also recommend inserting a power fuse for extra protection.

[Operating consideration]

- Illuminating phosphor will decrease in brightness during extended operation. If a fixed pattern illuminates for an extended period,(several hours), the phosphor efficiency will decrease compared to the non operating phosphor causing a non uniform brightness among pixels. Please consider programming the display patterns to use all phosphor segments evenly. Scrolling may be a consideration for a period of time to refresh the phosphor condition and improve even illumination to the pixels.
- We recommend using a signal cable 30cm or less to avoid some possible disturbances to the signal.

[Storage and operating environment]

- Please use VFD-modules under the recommended specified environmental conditions. Salty, sulfur and dusty environments may damage the VFD-module even during storage.

[Discard]

- Some VFDs contain a small amount of cadmium in the phosphor and lead in the solder. When discarding VFDs or VFD-modules, please adhere to governmental related laws or regulations.

[Others]

- Although the VFD-module is designed to be protected from electrical noise, please plan your circuitry to exclude as much noise as possible.
- Do not reconstruct or repair the VFD-module without our authorization. We cannot assure the quality or reliability of unauthorized reconstructed VFD-modules.

Notice:

- We do not authorize the use of any patents that may be inherent in these specifications.
- Neither whole nor partial copying of these specifications are permitted without our approval.
If necessary, please ask for assistance from our sales consultant.
- This product is not designed for military, aerospace, medical or other life-critical applications. If you choose to use this product for these applications, please ask us for prior consultation or we cannot take responsibility for problems that may occur.